

SCALE 1:2
FRONT SECTION

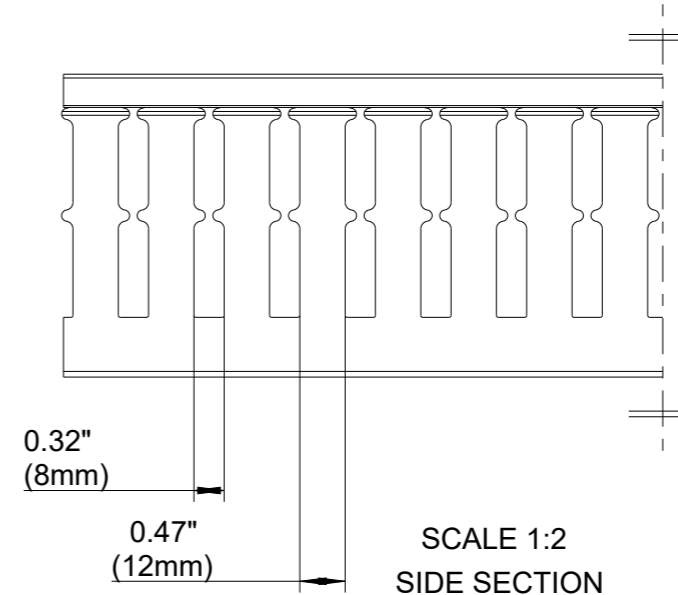

SCALE 1:2
SIDE SECTION

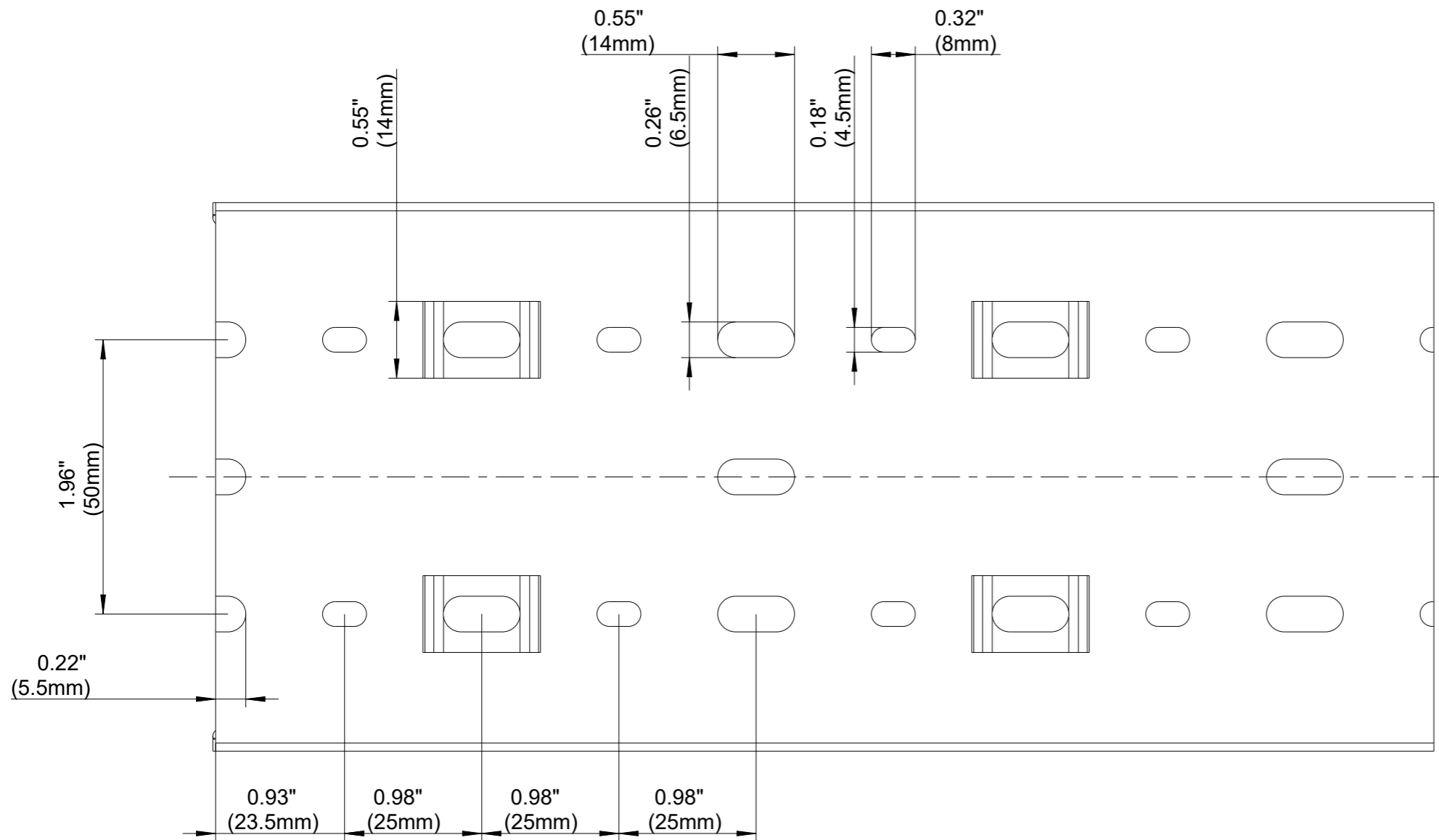

BASE PERFORATION



Ref. T1-F 100x80