

FRONT SECTION

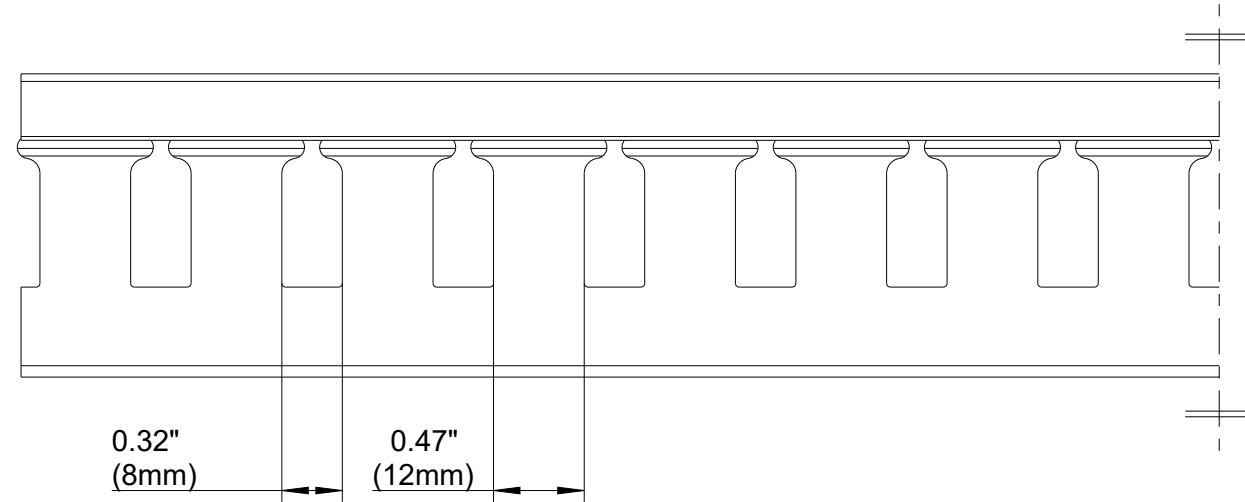

SIDE SECTION

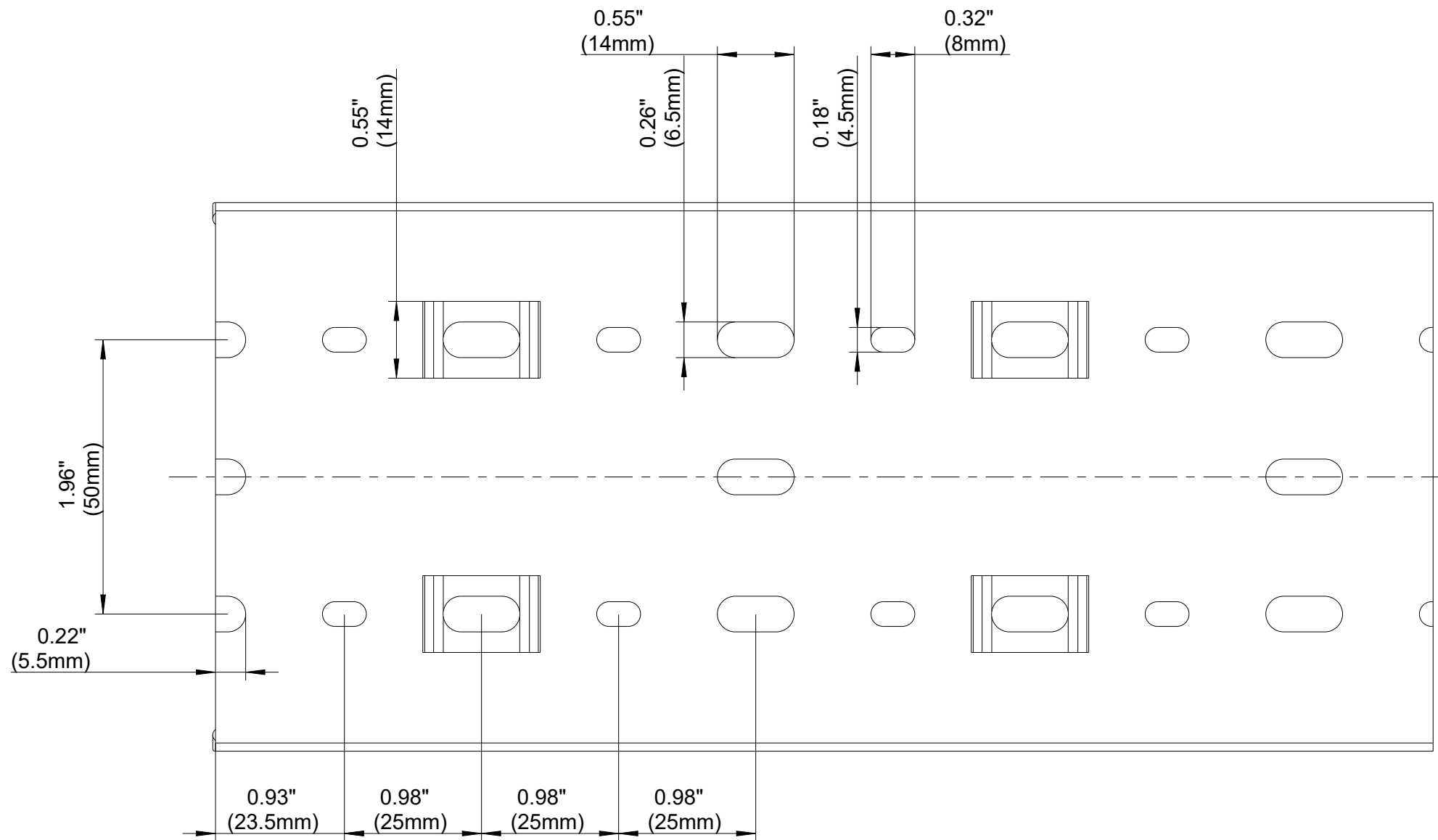

BASE PERFORATION



Ref. T1 100x40