



IBOCO Introduces CABLE MANAGEMENT Products



See Page 14

<http://www.iboco.com/cable-management-systems>

**See Our VTR's & Accessories
Pages 15 - 17**

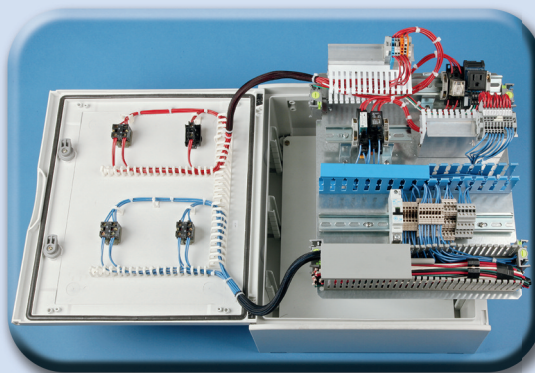
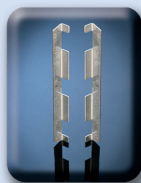

<http://www.iboco.com/all-enclosures/fiberglass-enclosures>

T1

OPEN SLOT RIGID PVC (including cover)

CATALOG NUMBER	NOMINAL SIZE (WxH)	SIZE (WxH) millimeters	LENGTHS PER CARTON	STANDARD CARTON - FT	LIST PRICE PER FOOT (3)
T1-0506G	1/2 x 5/8	15 x 18	20	120	\$3.88
T1-0510G	1/2 x 1	15 x 30	20	120	\$4.12
T1-0522G	1/2 x 2-1/4	15 x 60	16	96	\$5.04
T1-1010 *	1 x 1	25 x 30	18	108	\$4.94
T1-1015 *	1 x 1-1/2	25 x 40	18	108	\$6.12
T1-1022 *	1 x 2-1/4	25 x 60	24	144	\$6.70
T1-1030 *	1 x 3	25 x 80	24	144	\$8.22
T1-1040 *	1 x 4	25 x 100	8	48	\$9.66
T1-1515 *	1-1/2 x 1-1/2	40 x 40	20	120	\$6.84
T1-1522 *	1-1/2 x 2-1/4	40 x 60	18	108	\$7.42
T1-1530 *	1-1/2 x 3	40 x 80	16	96	\$9.04
T1-1540 *	1-1/2 x 4	40 x 100	8	48	\$10.38
T1-2215G	2-1/4 x 1-1/2	60 x 40	12	72	\$7.58
T1-2222 *	2-1/4 x 2-1/4	60 x 60	12	72	\$7.84
T1-2230 *	2-1/4 x 3	60 x 80	12	72	\$9.68
T1-2240 *	2-1/4 x 4	60 x 100	4	24	\$10.96
T1-3015G	3 x 1-1/2	80 x 40	12	72	\$9.62
T1-3022 *	3 x 2-1/4	80 x 60	12	72	\$9.98
T1-3030 *	3 x 3	80 x 80	12	72	\$11.70
T1-3040 *	3 x 4	80 x 100	4	24	\$13.34
T1-3050 *	3 x 5	75 x 125	6	36	\$17.68
T1-4015G	4 x 1-1/2	100 x 40	8	48	\$10.18
T1-4022G	4 x 2-1/4	100 x 60	8	48	\$11.02
T1-4030 *	4 x 3	100 x 80	8	48	\$12.68
T1-4040 *	4 x 4	100 x 100	4	24	\$15.30
T1-4050 *	4 x 5	100 x 125	4	24	\$20.68
T1-6040 *	6 x 4	150 x 100	4	24	\$24.04

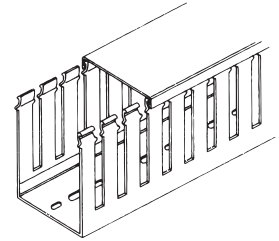

* COLOR - add suffix 'G' for Light Grey; 'W' for white;
 ADHESIVE BACKING - add suffix "A" to catalog number - contact sales office for pricing

T1-K

OPEN SLOT BLACK RIGID PVC (including cover)

Black Colored Duct

CATALOG NUMBER	NOMINAL SIZE (WxH)	SIZE (WxH) millimeters	LENGTHS PER CARTON	STANDARD CARTON - FT	LIST PRICE PER FOOT (3)
T1-1040K	1 x 4	25 x 100	8	48	\$9.74
T1-1530K	1-1/2 x 3	40 x 80	16	96	\$9.12
T1-2222K	2-1/4 x 2-1/4	60 x 60	12	72	\$7.90
T1-2240K	2-1/4 x 4	60 x 100	4	24	\$11.04
T1-3030K	3 x 3	80 x 80	12	72	\$11.82
T1-3040K	3 x 4	80 x 100	4	24	\$13.48
T1-3050K	3 x 5	75 x 125	6	36	\$17.90
T1-4040K	4 x 4	100 x 100	4	24	\$15.48
T1-4050K	4 x 5	100 x 125	4	24	\$20.88

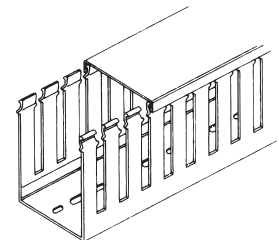

For special sizes contact sales office.

- NOTE : 1) All above prices include the cover
 2) Standard length is 6' 6 3/4" but is considered as 6 feet for the purpose of pricing and packaging
 3) List price per foot: cost premium for less than standard carton quantities

T1- B

OPEN SLOT BLUE RIGID PVC (including cover)

Blue Colored Duct

CATALOG NUMBER	NOMINAL SIZE (WxH)	SIZE (WxH) millimeters	LENGTHS PER CARTON	STANDARD CARTON - FT	LIST PRICE PER FOOT (3)
T1-1010B	1 x 1	25 x 30	18	108	\$5.18
T1-1022B	1 x 2-1/4	25 x 60	24	144	\$7.04
T1-1030B	1 x 3	25 x 80	24	144	\$8.68
T1-1515B	1-1/2 x 1-1/2	40 x 40	20	120	\$7.24
T1-1522B	1-1/2 x 2-1/4	40 x 60	18	108	\$7.86
T1-1530B	1-1/2 x 3	40 x 80	16	96	\$9.56
T1-2215B	2-1/4 x 1-1/2	60 x 40	12	72	\$8.00
T1-2222B	2-1/4 x 2-1/4	60 x 60	12	72	\$8.28
T1-2230B	2-1/4 x 3	60 x 80	12	72	\$10.14
T1-3030B	3 x 3	80 x 80	12	72	\$12.26
T1-3040B	3 x 4	80 x 100	4	24	\$14.96
T1-3050B	3 x 5	75 x 125	6	36	\$18.52
T1-4030B	4 x 3	100 x 80	8	48	\$13.28
T1-4040B	4 x 4	100 x 100	4	24	\$16.08

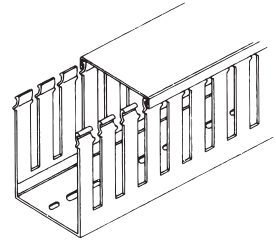

T1E

OPEN SLOT RIGID PVC (including cover)

CATALOG NUMBER	NOMINAL SIZE (WxH)	SIZE (WxH) millimeters	LENGTHS PER CARTON	STANDARD CARTON - FT	LIST PRICE PER FOOT (3)
T1E-1015*	1 x 1-1/2	25 x 40	18	108	\$6.12
T1E-1022*	1 x 2-1/4	25 x 60	24	144	\$6.70
T1E-1030*	1 x 3	25 x 80	24	144	\$8.22
T1E-1040*	1 x 4	25 x 100	8	48	\$9.66
T1E-1515*	1-1/2 x 1-1/2	40 x 40	20	120	\$6.84
T1E-1522*	1-1/2 x 2-1/4	40 x 60	18	108	\$7.42
T1E-1530*	1-1/2 x 3	40 x 80	16	96	\$9.04
T1E-1540*	1-1/2 x 4	40 x 100	8	48	\$10.38
T1E-2215G	2-1/4 x 1-1/2	60 x 40	12	72	\$7.58
T1E-2222*	2-1/4 x 2-1/4	60 x 60	12	72	\$7.84
T1E-2230*	2-1/4 x 3	60 x 80	12	72	\$9.68
T1E-2240*	2-1/4 x 4	60 x 100	4	24	\$10.96
T1E-3015G	3 x 1-1/2	80 x 40	12	72	\$9.62
T1E-3022*	3 x 2-1/4	80 x 60	12	72	\$9.98
T1E-3030*	3 x 3	80 x 80	12	72	\$11.70
T1E-3040*	3 x 4	80 x 100	4	24	\$13.34
T1E-4015G	4 x 1-1/2	100 x 40	8	48	\$10.18
T1E-4022G	4 x 2-1/4	100 x 60	8	48	\$11.02
T1E-4030*	4 x 3	100 x 80	8	48	\$12.68
T1E-4040*	4 x 4	100 x 100	4	24	\$15.30

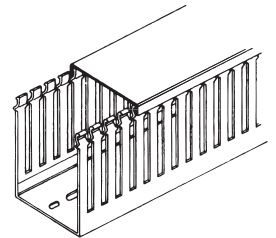

* COLOR - add suffix 'G' for Light Grey; 'W' for white
 ADHESIVE BACKING - add suffix "A" to catalog number - contact sales office for pricing

- NOTE : 1) All above prices include the cover
 2) Standard length is 6' 6 3/4" but is considered as 6 feet for the purpose of pricing and packaging
 3) Cost premium for less than standard carton quantities

TS/TSH

SOLID WALL RIGID PVC (including cover) TSH WITH MOUNTING HOLES

CATALOG NUMBER	NOMINAL SIZE (WxH)	SIZE (WxH) millimeters	LENGTHS PER CARTON	STANDARD CARTON - FT	LIST PRICE PER FOOT (3)
TSH-0506G	1/2 x 5/8	15 x 18	20	120	\$3.92
TSH-0510G	1/2 x 1	15 x 30	20	120	\$4.14
TSH-1010G	1 x 1	25 x 30	18	108	\$5.00
TSH-1015G	1 x 1-1/2	25 x 40	18	108	\$6.12
TSH-1030G	1 x 3	25 x 80	24	144	\$8.30
TSH-1515G	1-1/2 x 1-1/2	40 x 40	20	120	\$6.86
TSH-1522G	1-1/2 x 2-1/4	40 x 60	18	108	\$7.56
TSH-1530G	1-1/2 x 3	40 x 80	16	96	\$9.02
TSH-2222G	2-1/4 x 2-1/4	60 x 60	12	72	\$8.44
TSH-2230G	2-1/4 x 3	60 x 80	12	72	\$9.68
TSH-3022G	3 x 2-1/4	80 x 60	12	72	\$9.98
TSH-3030G	3 x 3	80 x 80	12	72	\$11.70
TSH-3040G	3 x 4	80 x 100	4	24	\$13.34
TSH-4030G	4 x 3	100 x 80	8	48	\$12.68
TSH-4040G	4 x 4	100 x 100	4	24	\$15.32

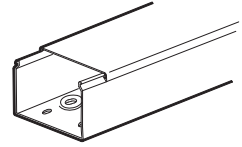

TSH - With Mounting Holes

SOLID WALL RIGID PVC (including cover) TS LESS MOUNTING HOLES

CATALOG NUMBER	NOMINAL SIZE (WxH)	SIZE (WxH) millimeters	LENGTHS PER CARTON	STANDARD CARTON - FT	LIST PRICE PER FOOT (3)
TS-0506G	1/2 x 5/8	15 x 18	20	120	\$3.92
TS-0510G	1/2 x 1	15 x 30	20	120	\$4.14
TS-1010G	1 x 1	25 x 30	18	108	\$5.00
TS-1015G	1 x 1-1/2	25 x 40	18	108	\$6.12
TS-1030G	1 x 3	25 x 80	24	144	\$8.30
TS-1515G	1-1/2 x 1-1/2	40 x 40	20	120	\$6.86
TS-1522G	1-1/2 x 2-1/4	40 x 60	18	108	\$7.56
TS-1530G	1-1/2 x 3	40 x 80	16	96	\$9.02
TS-2222G	2-1/4 x 2-1/4	60 x 60	12	72	\$8.44
TS-2230G	2-1/4 x 3	60 x 80	12	72	\$9.68
TS-3022G	3 x 2-1/4	80 x 60	12	72	\$9.98
TS-3030G	3 x 3	80 x 80	12	72	\$11.70
TS-3040G	3 x 4	80 x 100	4	24	\$13.34
TS-4030G	4 x 3	100 x 80	8	48	\$12.68
TS-4040G	4 x 4	100 x 100	4	24	\$15.32

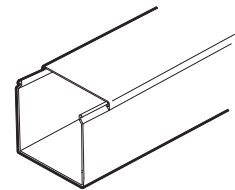

TS - Less Mounting Holes

Color - GREY

- Note: 1) All above prices include cover.
 2) Standard length is 6' 6 3/4" but is considered 6 feet for the purpose of pricing and packaging
 3) Cost Premium for less than standard carton quantities.

COV

COVERS - T1 - T1E - TS

CATALOG NUMBER	LENGTHS** PER CARTON	STANDARD CARTON - FT	LIST PRICE PER FOOT (3)
COV-05G	25	150	\$0.96
COV-10*	25	150	\$1.10
COV-15*	25	150	\$1.48
COV-22*	25	150	\$1.82
COV-30*	25	150	\$2.72
COV-40*	20	120	\$3.10
COV-60*	20	120	\$5.94

* COLOR - add suffix 'G' for Light Grey or 'W' for white

**Each length is 6' 6 3/4" long

CTN

REPACK BOXES

CATALOG NUMBER	DIMENSIONS	LIST PRICE EACH
CTN4278	78.75 X 3.5 X 1.6875	\$6.24
CTN4672	79 X 6.5 X 4.25	\$6.24

MT

ADHESIVE

CATALOG NUMBER	DESCRIPTION	FEET/ ROLL	PRICE/ ROLL
MT-32A50	1/2" Rubber based double sided	216	\$39.52
MT-32A75	3/4" Rubber based double sided	216	\$45.76

SEP-E

SEPARATORS

CATALOG NUMBER	FOR DUCT HEIGHTS	LENGTHS* PER CARTON	STANDARD CARTON - FT	LIST PRICE PER FOOT
SEP-15E	1-1/2	32	192	\$1.50
SEP-22E	2-1/4	20	120	\$2.16
SEP-30E	3	12	72	\$2.38

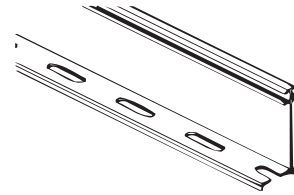

* Each length is 6' 6 3/4" long but is considered as 6 feet for the purpose of pricing and packaging

DUCTFIX

RIVETS

CATALOG NUMBER	QUANTITY PER PACK	LIST PRICE PER PACK*
R4(1)	250	\$20.60
R6N(2)	250	\$23.82
R6O(3)	250	\$24.76

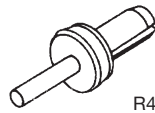

R4

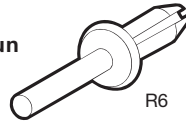

R6

* Sold in pack quantity only

- (1) Blue color - Can be used with B4 or RT4 Rivet Gun
- (2) Natural color - Use only with B6 Rivet Gun
- (3) Orange color - Use only with RT6 Rivet Gun

DUCTMARK

IDENTIFICATION TAGS

CATALOG NUMBER	QUANTITY PER PACK	LIST PRICE EACH PC*
DM 1	50	\$0.62

* Sold in pack quantity only

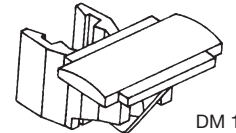

DM 1

B4 • B6 • RT4 • RT6

RIVET GUN

CATALOG NUMBER	PIECES PER PACK	LIST PRICE EACH
B4(1)	1	\$52.00
B6(1)	1	\$52.00
RT4(2)	1	\$108.16
RT6(2)	1	\$108.16

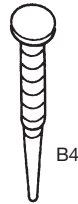

B4

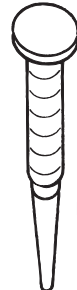

B6

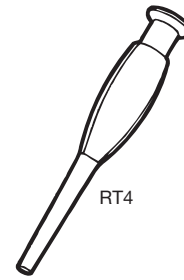

RT4

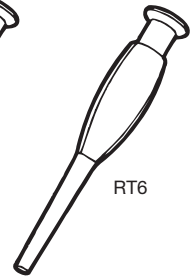

RT6

(1) Plastic

(2) Metallic - Note different rivets for RT6

ZP1 • ZP2

MOUNTING INSERTS - CABLE TIE ATTACHMENTS

CATALOG NUMBER	PIECES PER PACK	LIST PRICE PER PACK
ZP1	100	\$14.36
ZP2	50	\$18.20



ZP1



ZP2

CL

WIRE RETAINERS**

CATALOG NUMBER #	CODE	PIECES PER PACK	LIST PRICE EACH PC*
CL-1515	05104	40	\$1.34
CL-1522	05107	40	\$1.46
CL-1530	05113	20	\$1.60
CL-2215	05105	40	\$1.62
CL-2222	05108	20	\$1.78
CL-2230	05114	20	\$1.84
CL-2240	05118	20	\$2.04
CL-3022	05109	10	\$2.24
CL-3030	05124	10	\$2.46
CL-3040	05129	10	\$2.54
CL-4022	05110	10	\$2.46
CL-4030	05115	10	\$2.60
CL-4040	05119	5	\$3.34
CL-6040	05120	5	\$4.24

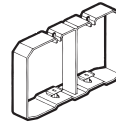
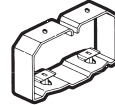

TR

WIRE RETAINERS

CATALOG NUMBER	PIECES PER PACK	LIST PRICE PER PACK*
TR1	50	\$37.00
TR1E	50	\$37.00

* Per pack

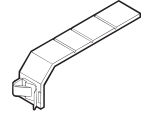

Catalog number indicates to which duct size (WxH) the CL will fit.

* Sold in pack quantity only

** Product label will be marked with the catalog number or code.

SPIRALITE

UNIVERSAL SPIRAL WRAP

CATALOG NUMBER	FEET PER PACK	NOMINAL O.D. SIZE	LIST PRICE PER PACK*		
			P	PA	PK**
P1 - PA1 - P1K	160	0.125	\$20.14	\$29.82	\$35.20
P2 - PA2 - P2K	80	0.25	\$21.76	\$30.88	\$43.40
P3 - PA3 - P3K	80	0.375	\$35.02	\$56.22	\$65.26
P4 - PA4 - P4K	65	0.50	\$46.36	\$71.62	\$81.90



* Sold in pack quantity only

P = Polyethylene - natural

PA = Polyethylene - white

PK = Polyethylene - Black

** Color Black - 100 ft rolls only

SLEEVING

BRAIDED EXPANDABLE SLEEVING

Polyester

CATALOG NUMBER	NOMINAL I.D.		NOMINAL DIAMETER RANGE		COLOR	QTY PER PACK	LIST PRICE PER PACK
	Inches	(mm)	Inches	(mm)			
TY-5*	.197	(5)	.157	(4)	Black & Grey	325	\$140.40
TY-10*	.375	(10)	.315	(8)		325	\$270.40
TY-20*	.750	(20)	.630	(16)		164	\$237.12
TY-30*	1.125	(30)	.984	(25)		164	\$332.80
TY-50*	2.000	(50)	1.575	(40)		164	\$509.60

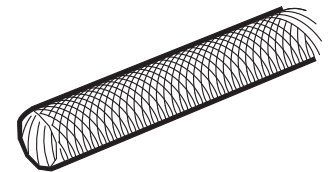

Polyester - Halogen Free - Rated -58°F to +302°F (-50°C to +150°C)

* COLOR - add suffix "G" for Grey and "B" for Black

DINOSAUR

FLEXIBLE DUCTS SELF - ADHESIVE

CATALOG NUMBER	NOMINAL SIZE (WxH)	LENGTHS* PER CARTON	LIST PRICE EACH LGTH.
DN 25A**	1/2 x 3/4	24	\$5.96
DN 35A**	1 x 1 3/8	24	\$8.18
DN 45A**	1 3/8 x 1 3/4	14	\$10.94

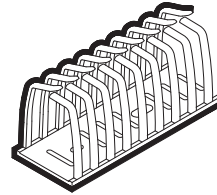

Each length is 19.7 inches (500mm)

** Color: add suffix "G" for Grey or "W" for white"

Sold in carton quantity only

DIN RAILS

CATALOG NUMBER	TYPE STEEL	STD PACK FEET	LENGTHS PER PACK	LIST PRICE PER LENGTH		
				ONE PACK	120 PCS	480 PCS
G1	Solid	78	12	\$12.18	CALL	CALL
G1F	With Holes	78	12	\$10.92	\$9.94	CALL
G1F1*	With Holes	78	24	\$6.20	\$5.80	CALL
OMEGA 2F	With Holes	130	20	\$6.48	\$5.94	CALL
OMEGA 2F1*	With Holes	130	40*	\$3.44	\$3.14	CALL
OMEGA 3	Solid	130	20	\$7.32	\$6.66	\$6.04
OMEGA 31*	Solid	130	40*	\$4.42	CALL	CALL
OMEGA 3F	With Holes	130	20	\$7.56	\$6.74	\$6.40
OMEGA 3F1*	With Holes	130	40*	\$4.12	\$3.66	\$3.38
OMEGA 3FD	With Holes	130	20	\$8.34	\$7.66	\$7.22
OMEGA 3A	Solid	65	10	\$10.70	\$9.86	\$9.40
OMEGA 3A1*	Solid	65	20*	\$6.50	CALL	CALL
OMEGA 3AF	With Holes	65	10	\$11.62	\$10.68	\$9.76
OMEGA 3AF1*	With Holes	65	20*	\$6.86	\$6.40	\$5.70
OMEGA 3AFD	With Holes	65	10	\$13.76	\$12.68	\$11.62
OMEGA 3B	Solid	65	10	\$17.78	\$16.32	CALL
OMEGA 3B1*	Solid	65	20*	\$9.80	\$9.36	CALL
OMEGA 75	Solid	13	2	\$78.76	n/a	n/a

ALUMINUM

OMEGA 32A1*	2" Elevated	19.5	6*	\$21.06	\$19.30	CALL
OMEGA 32A2	2" Elevated	39	6	\$39.38	\$36.34	CALL
OMEGA 3FAL1*	With Holes	130	40*	\$7.58	\$7.00	\$6.54
OMEGA 345A2	4-1/2" Elevated	13	2	\$92.48	CALL	CALL

COPPER

OMEGA 3ACU	Solid	6.5	1	\$110.24	CALL	
------------	-------	-----	---	----------	------	--

STAINLESS STEEL

OMEGA 3SS	Solid	26	4	\$36.58	CALL	
OMEGA 3SS1*	Solid	26	8*	\$20.26	CALL	

NOTE: 1) Sold in pack quantities only

2) Each length is 2 meters long (6' 6 3/4") except as noted

* One meter long

ST • DINFIX • DINCLIC

CATALOG NUMBER	PIECES PER PACK	LIST PRICE EACH PC
ST*	10	\$2.16
STS 25*	10	\$2.86
STS 50*	10	\$3.06
STS 70*	10	\$3.86
STS 90*	10	\$4.06
DINFIX 64	50	\$0.86
DINFIX 53	50	\$0.86
DINCLIC DM4	40	\$1.30
DINCLIC FM4	40	\$1.56
DINCLIC FM5	40	\$1.56

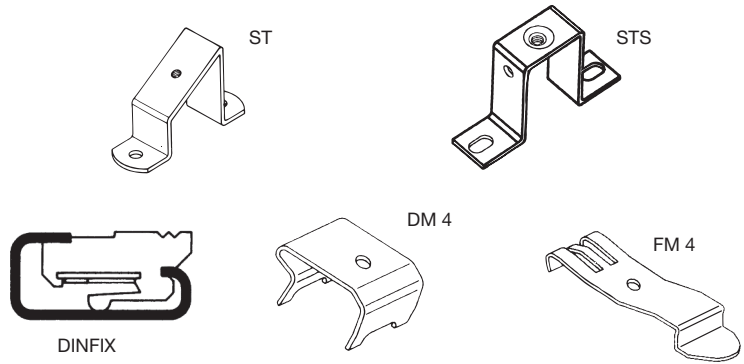

*All ST & STS products supplied with 6mm Screws

DINBLOK

MOUNTING BLOCKS

CATALOG NUMBER	PIECES PER PACK	LIST PRICE EACH PC
DINBLOK 3	25	\$1.46

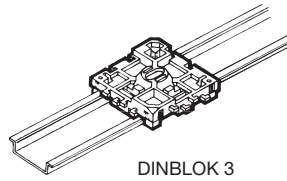

TOOLS

CATALOG NUMBER	DESCRIPTION	QUANTITY PER PACK	LIST PRICE EACH
BA7	Wire Duct Cutter	1	\$1500.00
SX-15	Hand Duct Cutter	1	\$140.40
SX-15B	Blade	1	\$62.40
WT-2	Duct and Tubbing Cutter	1	\$130.00
WT-2B	Blade	1	\$52.00
TRITON	Side wall cutter	1	\$193.44
DC-510	Rail Cutter	1	\$2,500.00
DCA-100	Aluminum Rail Cutter	1	\$1,196.00

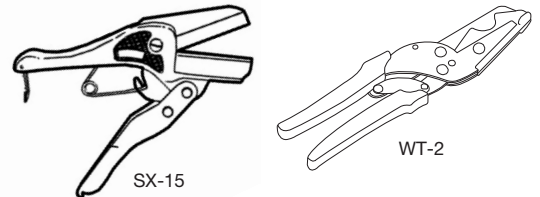

CABLE TIES

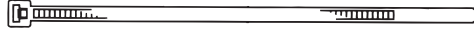

CATALOG NUMBER	QUANTITIES AVAILABLE	LENGTH in. (mm)	MIN. LOOP TENSILE STRENGTH	MAXIMUM BUNDLE DIA. in. (mm)	PRICE PER QTY.		
					100 PC.	1000 PC.	
ICT-18R	C-M	3.96 (100)	18 LBS.	.875 (22)	\$5.78	\$25.84	
ICT-18RB	C-M	"		"	\$6.36	\$28.44	
ICT-18L	C-M	6.15 (156)		1.63 (41)	\$6.66	\$34.46	
ICT-18LB	C-M	"		"	\$7.32	\$37.90	
ICT-18V	C-M	8.0 (203)		2 (50)	\$7.64	\$42.34	
ICT-18VB	C-M	"		"	\$8.40	\$46.60	
ICT-40R	C-M	5.78 (146)	40 LBS.	1.38 (35)	\$8.48	\$44.50	
ICT-40RB	C-M	"		"	\$9.32	\$48.96	
ICT-40L	C-M	8.78 (223)		2.13 (54)	\$9.74	\$53.98	
ICT-40LB	C-M	"		"	\$10.72	\$59.38	
ICT-50R	C-M	7.49 (190)	50 LBS.	1.75 (44)	\$11.44	\$51.80	
ICT-50RB	C-M	"		"	\$12.60	\$57.00	
					100 PC.	500 PC.	
ICT-50T	C-D	11.3 (287)	50 LBS.	3 (76)	\$18.20	\$68.20	
ICT-50TB	C-D	"		"	"	\$20.00	\$75.10
ICT-50L	C-D	14.5 (368)		4 (102)	\$22.50	\$82.00	
ICT-50LB	C-D	"		"	"	\$24.74	\$90.20
					50 PC.	100 PC.	
ICT-120R	C	15 (381)	120 LBS.	4 (103)	n/a	\$33.90	
ICT-120RB	C	"		"	"	n/a	\$37.30
ICT-120T	L	18 (457)		5.25 (133)	\$28.00	n/a	
ICT-120TB	L	"		"	\$30.50	n/a	
ICT-120V	L	24 (610)		7 (178)	\$44.00	n/a	
ICT-120VB	L	"		"	\$48.40	n/a	
ICT-120X	L	28 (711)		8 (203)	\$52.00	n/a	
ICT-120XB	L	"		"	\$57.20	n/a	

CABLE TIES

IDENTIFICATION & FLAG TAGS

CATALOG NUMBER	QUANTITIES AVAILABLE	LENGTH in. (mm)	MIN. LOOP TENSILE STRENGTH	MAXIMUM BUNDLE DIA. in. (mm)	PAD SIZE	PRICE PER QTY. 100 PC. ONLY
ICT-18IDR	C	4 (101)	18 LBS.	.63 (16)	5/16 x 1	\$21.00
ICT-18FLR	C	"		"	"	5/16 x 13/16
ICT-50IDS	C	7 (177)	50 LBS.	1.75 (44)	1/2 x 1/8	\$31.60
ICT-50IDL	C	14 (358)		4 (102)	1/2 x 2 1/4	\$55.66

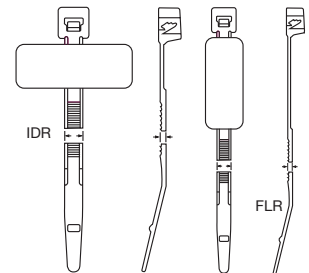

CABLE TIES

EXTRA HEAVY DUTY

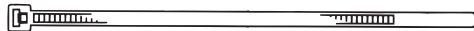

CATALOG NUMBER	QUANTITIES AVAILABLE	LENGTH in. (mm)	MIN. LOOP TENSILE STRENGTH	MAXIMUM BUNDLE DIA. in. (mm)	PRICE PER QTY.	
					50 PC.	100 PC.
ICT-175V	L	24 (610)	175 LBS	7.2 (183)	\$43.20	n/a
ICT-175VB	L	"		"	\$47.50	n/a
ICT-175R	L	37 (940)		11 (279)	\$46.50	n/a
ICT-175RB	L	"		"	\$51.10	n/a
ICT-175T	L	48 (1219)		14.5 (368)	\$107.50	n/a
ICT-175TB	L	"		"	\$118.24	n/a
ICT-250R	C	22.8 (579)	250 LBS	6 (152)	n/a	\$111.30
ICT-250RB	C	"		"	"	n/a

Add following suffix to number to indicate quantity

M= 1,000 pc package (ie..ICT-18R-M)

D= 500 pc package (ie..ICT-50T-D)

C= 100 pc package (ie..ICT-18R-C)

L= 50 pc package (ie..ICT-120R-L)

Suffix B indicates Black

MIL-SPEC Ties - Natural only

For additional colors/sizes contact sales office

CABLE TIES

RELEASABLE

CATALOG NUMBER	QUANTITIES AVAILABLE	LENGTH		MIN. LOOP TENSILE STRENGTH	MAXIMUM BUNDLE DIA.	PRICE PER QTY. 100 PC. ONLY
		in.	(mm)			
ICT-50RLR	C	5.9	(149)	50 LBS	1.25 (32)	\$24.38
ICT-50RLRB	C	"	"		"	\$27.10
ICT-50RLS	C	7.8	(198)		2 (51)	\$27.78
ICT-50RLSB	C	"	"		"	\$30.56
ICT-50RLL	C	11.75	(298)		3 (76)	\$50.46
ICT-50RLLB	C	"	"		"	\$55.50

Suffix B indicates Black

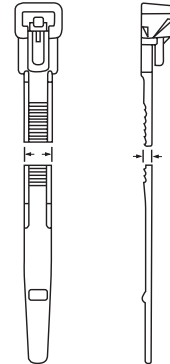

CABLE TIES

MOUNTING HOLES

CATALOG NUMBER	QUANTITIES AVAILABLE	LENGTH		MIN. LOOP TENSILE STRENGTH	MAXIMUM BUNDLE DIA.	SCREW HOLE	PRICE PER QTY.	
		in.	(mm)				100 PC.	1000 PC.
ICT-30MHR	C	6	(152)	30 LBS.	1.25 (32)	NO.8	\$21.00	n/a
ICT-30MHRB	C	"	"	"	"	"	\$23.10	n/a
ICT-50MHS	C-M	8	(205)	50 LBS.	1.75 (44)	NO.10	\$24.38	\$124.34
ICT-50MHSB	C-M	"	"	"	"	"	\$26.82	\$136.74

100 PC.

ICT-50MHT	C	11.7	(298)	50 LBS.	3 (76)	NO.10	\$56.00
ICT-50MHTB	C	"	"	"	"		\$61.60
ICT-50MHL	C	14	(368)	"	4 (102)		\$57.66
ICT-50MHLB	C	"	"	"	"		\$63.40
ICT-120MHL	C	15	(396)	120 LBS.	4 (102)	NO.10	\$67.84
ICT-120MHLB	C	"	"	"	"	"	\$74.62

Suffix B indicates Black

Add following suffix to number to indicate quantity

- M= 1,000 pc package (ie..ICT-18R-M)
- D= 500 pc package (ie..ICT-18R-D)
- C= 100 pc package (ie..ICT-18R-C)
- L= 50 pc package (ie..ICT-18R-L)

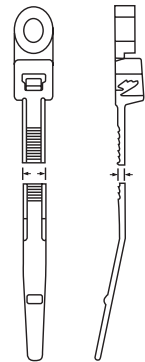

CABLE MOUNTS

CATALOG NUMBER	PRICE PER QTY. 100 PC.
ICM-50	\$17.50
ICM-75	\$23.96
ICM-75B	\$26.36
ICM-100	\$35.66
ICM-100B	\$39.20

ICM-75 and 100

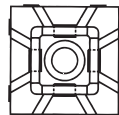

Color - Standard - Natural
Suffix "B" indicates Black

INSTALLATION TOOLS

CATALOG NUMBER	PRICE EACH
ITT-1	\$26.00
ITT-2A	\$114.00

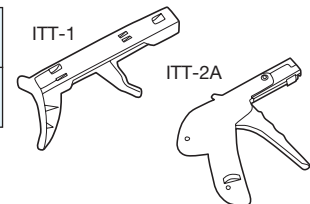

LIQUIDTIGHT CONDUIT

NON METALLIC

CATALOG NUMBER	NOMINAL ID	ACTUAL ID	COIL LENGTH	LIST PRICE PER COIL
GSI-12*	3/8	0.47	98' (30MTRS)	\$53.26
GSI-16*	1/2	0.63	98' (30MTRS)	\$63.76
GSI-20*	3/4	0.79	98' (30MTRS)	\$77.80
GSI-25*	1	0.98	98' (30MTRS)	\$131.46
GSI-32*	1-1/4	1.25	98' (30MTRS)	\$185.12
GSI-40*	1-1/2	1.57	98' (30MTRS)	\$231.92
GSI-50*	2	1.97	98' (30MTRS)	\$303.26

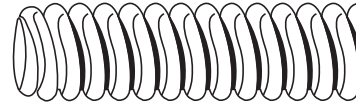

* COLOR - add suffix 'G' for Light Grey; 'K' for Black

STRAIGHT LIQUIDTIGHT FITTING

CATALOG NUMBER	NOMINAL ID	ACTUAL ID	PCS PER PACK	LIST PRICE EACH PC
RPS-12*	3/8	0.47	20	\$1.72
RPS-16*	1/2	0.63	20	\$1.98
RPS-20*	3/4	0.79	20	\$2.48
RPS-25*	1	0.98	10	\$3.62
RPS-32*	1-1/4	1.25	10	\$7.44
RPS-40*	1-1/2	1.57	5	\$11.04
RPS-50*	2	1.97	5	\$19.96



* COLOR - add suffix 'G' for Light Grey; 'K' for Black

90° LIQUIDTIGHT FITTING

CATALOG NUMBER	NOMINAL ID	ACTUAL ID	PCS PER PACK	LIST PRICE EACH PC
CUR-12*	3/8	0.47	25	\$2.98
CUR-16*	1/2	0.63	25	\$3.52
CUR-20*	3/4	0.79	15	\$3.94
CUR-25*	1	0.98	5	\$5.68
CUR-32*	1-1/4	1.25	5	\$14.44

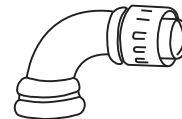

* COLOR - add suffix 'G' for Light Grey; 'K' for Black

GASKETS

CATALOG NUMBER	FITS RA/CUR	PCS PER PACK	LIST PRICE EACH PC
GT-12	12	25	\$0.22
GT-16	16	25	\$0.22
GT-20	20	25	\$0.20
GT-25	25	20	\$0.26
GT-32	32	20	\$0.26
GT-40	40	10	\$0.42
GT-50	50	10	\$0.42

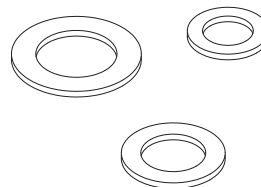

PC SERIES NON-METALLIC ENCLOSURES*

Solid Cover Boxes -SS screws IP56

CATALOG NUMBER	CODE	OUTSIDE DIMENSIONS (IN.)			INSIDE DIMENSIONS (IN.)			LIST PRICE
		L	W	H	L	W	H	
PC-442S	04841	4.0	4.0	2.3	3.9	3.9	1.9	\$5.94
PC-532S	04842	4.9	3.3	2.3	4.7	3.1	1.9	\$6.16
PC-643S	04843	6.0	4.5	3.0	5.9	4.3	2.6	\$9.28
PC-753S	04844	7.7	5.9	3.1	7.5	5.7	2.6	\$14.72
PC-974S	04845	9.8	7.7	3.9	9.6	7.5	3.4	\$28.76
PC-1295S	04846	12.2	9.0	5.0	12.0	8.9	4.4	\$43.68
PC-15125S	04847	15.3	12.2	5.0	15.0	11.9	4.4	\$62.38
PC-18155S	04848	18.3	15.5	5.0	18.1	15.1	4.4	\$85.18



Raised Cover, Solid Boxes - SS screws IP56

CATALOG NUMBER	CODE	OUTSIDE DIMENSIONS (IN.)			INSIDE DIMENSIONS (IN.)			LIST PRICE
		L	W	H	L	W	H	
PC-976RS	04849	9.8	8.0	6.5	9.6	7.5	6.0	\$36.16
PC-1297RS	04850	12.2	9.4	7.4	12.0	8.9	7.0	\$49.78
PC-15127RS	04851	15.3	12.4	7.4	15.0	11.9	7.0	\$71.86
PC-18157RS	04852	18.3	15.5	7.4	18.1	15.1	7.0	\$97.24



Transparent Cover Boxes -SS screws IP56

CATALOG NUMBER	CODE	OUTSIDE DIMENSIONS (IN.)			INSIDE DIMENSIONS (IN.)			LIST PRICE
		L	W	H	L	W	H	
PC-643C	04853	6.0	4.5	3.0	5.9	4.3	2.6	\$13.62
PC-753C	04854	7.7	5.9	3.1	7.5	5.7	2.6	\$20.38
PC-974C	04855	9.8	7.7	3.9	9.6	7.5	3.4	\$35.46
PC-1295C	04856	12.2	9.0	5.0	12.0	8.9	4.4	\$56.68
PC-15125C	04857	15.3	12.2	5.0	15.0	11.9	4.4	\$84.24
PC-18155C	04858	18.3	15.5	5.0	18.1	15.1	4.4	\$115.34



Solid Cover Boxes with holes and plugs -SS screws IP55

CATALOG NUMBER	CODE	OUTSIDE DIMENSIONS (IN.)			INSIDE DIMENSIONS (IN.)			LIST PRICE
		L	W	H	L	W	H	
PC-442S/6P	04831	4.0	4.0	2.3	3.9	3.9	1.9	\$6.46
PC-532S/6P	04832	4.9	3.3	2.3	4.7	3.1	1.9	\$6.66
PC-643S/10P	04833	6.0	4.5	3.0	5.9	4.3	2.6	\$10.20
PC-753S/10P	04834	7.7	5.9	3.1	7.5	5.7	2.6	\$17.90
PC-974S/12P	04835	9.8	7.7	3.9	9.6	7.5	3.4	\$32.46
PC-1295S/12P	04836	12.2	9.0	5.0	12.0	8.9	4.4	\$52.52
PC-15125S/12P	04837	15.3	12.2	5.0	15.0	11.9	4.4	\$71.46
PC-18155S/14P	04838	18.3	15.5	5.0	18.1	15.1	4.4	\$94.86



* Made of ABS.

SMALL BOXES WITH HOLES*

Small Boxes with Holes and Plugs IP44**

PART NUMBER	CODE	OUTSIDE DIMENSIONS (IN.)	INSIDE DIMENSIONS (IN.)	LIST PRICE
PC-25D15/4P	04461	2.5D x 1.4	2.4D x 1.5	\$3.64
PC-3315/6P	04463	3.3 x 3.3 x 1.6	3.1 x 3.1 x 1.6	\$5.52

* Made of ABS.



ENCLOSURE ACCESSORIES

Mounting Feet**

PART NUMBER	CODE	DESCRIPTION	LIST PRICE
MF-97*	04861	For use on PC -753 or larger	0.62

* Must order in packs of 12.



Rubber Caps - PC Series**

TDI-16	04859	For use on PC4 to PC6	\$0.38
TDI-20	04860	For use on PC7 to PC18	\$0.38
TDI-28	05164	Rubber Cap for ICB Boxes	\$0.38



Mounting Plates**

PART NUMBER	CODE	DIMENSIONS	LIST PRICE
MP-75S	04862	PFP 04 (7x5)	\$9.78
MP-97S	04863	PFP 05 (9x7)	\$14.78
MP-129S	04864	PFP 06 (12x9)	\$18.10
MP-1512S	04865	PFP 07 (15x12)	\$31.10
MP-1815S	04866	PFP 08 (18x15)	\$40.04



ICB SERIES

Circuit Breaker & Control Enclosures IP65**

ICB-0465	06521	04 Pole 210x143x102mm	(8.3x5.6x4in.)	\$45.04
ICB-0865	06522	08 Pole 210x215x105mm	(8.3x8.5x4in.)	\$57.42
ICB-1265	06523	12 Pole 263x314x143mm	(10.4x12.4x5.6in.)	\$105.56
ICB-1865	06524	18 Pole 288x426x148mm	(11.3x16.8x5.8in.)	\$148.42
ICB-2465	06525	24 Pole 420x314x143mm	(16.5x12.4x5.6in.)	\$172.12
ICB-3665	06526	36 Pole 470x426x148mm	(18.5x16.8x5.8in.)	\$231.30
ICB-5465	06527	54 Pole 657x426x148mm	(25.9x16.8x5.8in.)	\$309.62
ICB-7265	06528	72 Pole 903x426x168mm	(35.6x16.8x6.6in.)	\$384.92



ICB Enclosure Accessories**

SR-65	05161	Key Lock	\$19.76
RG	05163	Circuit Breaker Riser	\$1.46
SEC	05160	Mounting Feet for ICB Boxes	\$0.74
MRS-8	05168	16pt. Distribution Block for ICB 08 or Larger	\$23.50
CS-6	05180	6 Circuit Breaker Spacers	\$0.62

** Product label will be marked with the Catalog Number or Code.





CABLE MANAGEMENT PRODUCTS

HORIZONTAL - SINGLE SIDED



IBOCO PART#	DESCRIPTION	LIST PRICE (EA.)
IEWM104-1	1U Cable Management Panel, 1.5 x 2, Single-Sided, 17.25 Cover	\$51.66
IEWM104-2	1U Cable Management Panel, 1.5 x 2, Single-Sided, 20.125 Cover	\$52.92
IEWM105-1	1U Cable Management Panel, 1.5 x 3, Single-Sided, 17.25 Cover	\$55.42
IEWM105-2	1U Cable Management Panel, 1.5 x 3, Single-Sided, 20.125 Cover	\$56.82
IEWM106-1	2U Cable Management Panel, 3 x 3, Single-Sided, 17.25 Cover	\$56.74
IEWM106-2	2U Cable Management Panel, 3 x 3, Single-Sided, 20.125 Cover	\$57.72

HORIZONTAL - DOUBLE SIDED

IBOCO PART#	DESCRIPTION	LIST PRICE (EA.)
IEWM101-1	2U Cable Mgmt. Panel, 3 x 3 Front, 2 x 4 Rear, 17.25 Covers Front & Rear	\$79.42
IEWM101-2	2U Cable Mgmt. Panel, 3 x 3 Front, 2 x 4 Rear, 20.125 Front Cover, 17.25 Rear Cover	\$81.40
IEWM102-1	1U Cable Mgmt. Panel, 1.5 x 3 Front, 1 x 4 Rear, 17.25 Covers Front & Rear	\$80.28
IEWM102-2	1U Cable Mgmt. Panel, 1.5 x 3 Front, 1 x 4 Rear, 20.125 Front Cover, 17.25 Rear Cover	\$80.92
IEWM103-1	1U Cable Mgmt. Panel, 1.5 x 2 Front, 1 x 4 Rear, 17.25 Covers Front & Rear	\$77.98
IEWM103-2	1U Cable Mgmt. Panel, 1.5 x 2 Front, 1 x 4 Rear, 20.125 Front Cover, 17.25 Rear Cover	\$80.20

VERTICAL - SINGLE SIDED

IBOCO PART#	DESCRIPTION	LIST PRICE (EA.)
IEWM202-1	Vertical Cable Management Panel, 4 x 5 x 35 Long, Side Mount w/Cover	\$118.84
IEWM204-1	Vertical Cable Management Panel, 4 x 5 x 35 Long, Center Mount w/Cover	\$118.84
IEWM302-1	Vertical Cable Management Panel, 4 x 5 x 78 Long, Side Mount w/Cover	\$211.18
IEWM304-1	Vertical Cable Management Panel, 4 x 5 x 78 Long, Center Mount w/Cover	\$217.78

VERTICAL- DOUBLE SIDED

IBOCO PART#	DESCRIPTION	LIST PRICE (EA.)
IEWM201-1	Vertical Cable Management Panel, 4 x 5 x 35 Long, Side Mount w/Covers	\$167.08
IEWM203-1	Vertical Cable Management Panel, 4 x 5 x 35 Long, Center Mount w/Covers	\$191.86
IEWM301-1	Vertical Cable Management Panel, 4 x 5 x 78 Long, Side Mount w/Covers	\$386.64
IEWM303-1	Vertical Cable Management Panel, 4 x 5 x 78 Long, Center Mount w/Covers	\$363.18

EXTENSION BRACKET

IBOCO PART#	DESCRIPTION	PCS/PACK	LIST PRICE (EA.)
ITELWM-EXTBRK	Extension Bracket 19-23 extension	2 pcs / pack	\$13.76

VTR FIBERGLASS ENCLOSURES*

CIECO - SOLID DOOR

ITEM	CODE	SIZE (IN.)	LIST PRICE
VTR01C	06671	11.8 x 9.2 x 6.5	\$163.24
VTR02C	06672	16.7 x 12.8 x 7.1	\$203.08
VTR03C	06673	19.7 x 16.9 x 8.3	\$244.12
VTR04C	06674	25.6 x 16.9 x 8.3	\$301.76
VTR05C	06675	25.6 x 21.3 x 10.2	\$389.92
VTR06C	06676	31.7 x 24.2 x 12.4	\$1,300.00
VTR07C	06677	41.8 x 31.9 x 14.0	\$1,800.00



OBLO - WINDOW DOOR

ITEM	CODE	SIZE (IN.)	LIST PRICE
VTR01O	04621	11.8 x 9.2 x 6.5	\$188.88
VTR02O	04622	16.7 x 12.8 x 7.1	\$229.08
VTR03O	04623	19.7 x 16.9 x 8.3	\$286.04
VTR04O	04624	25.6 x 16.9 x 8.3	\$320.92
VTR05O	04625	25.6 x 21.3 x 10.2	\$432.80



CIECO - SOLID DOOR WITH STAINLESS STEEL KEY

ITEM	SIZE (IN.)	LIST PRICE
VTR01C-SS	11.8 x 9.2 x 6.5	\$170.44
VTR02C-SS	16.7 x 12.8 x 7.1	\$210.28
VTR03C-SS	19.7 x 16.9 x 8.3	\$251.32
VTR04C-SS	25.6 x 16.9 x 8.3	\$308.96
VTR05C-SS	25.6 x 21.3 x 10.2	\$397.12
VTR06C-SS	31.7 x 24.2 x 12.4	\$1,307.20
VTR07C-SS	41.8 x 31.9 x 14.0	\$1,807.20

OBLO - WINDOW DOOR WITH STAINLESS STEEL KEY

ITEM	SIZE (IN.)	LIST PRICE
VTR01O-SS	11.8 x 9.2 x 6.5	\$196.08
VTR02O-SS	16.7 x 12.8 x 7.1	\$236.28
VTR03O-SS	19.7 x 16.9 x 8.3	\$293.24
VTR04O-SS	25.6 x 16.9 x 8.3	\$328.12
VTR05O-SS	25.6 x 21.3 x 10.2	\$440.00

* Pages 15-17 -Special Terms - See page 18 - III



STEEL MOUNTING PLATE

ITEM#	CODE	LIST PRICE
PFVTR01	04670	\$14.56
PFVTR02	04671	\$19.16
PFVTR03	04672	\$25.72
PFVTR04	04673	\$35.56
PFVTR05	04674	\$43.20
PFVTR06	04675	\$61.04
PFVTR07	04677	\$109.24



INSULATED MOUNTING PLATE

ITEM#	CODE	LIST PRICE
PFVTR01IS	04690	\$19.04
PFVTR02IS	04691	\$27.44
PFVTR03IS	04692	\$42.72
PFVTR04IS	04693	\$53.16
PFVTR05IS	04694	\$68.24
PFVTR06IS	04695	\$96.28



BLANK PANEL

ITEM#	CODE	LIST PRICE
PCVTR12	04645	\$11.24
PCVTR18	04646	\$10.28
PCVTR24	04647	\$16.92
PCVTR28	04648	\$14.64
PCVTR38	04649	\$44.72

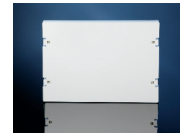

DOUBLE BLANK PANEL

ITEM#	CODE	LIST PRICE
PCVTR12DO	04696	\$13.04
PCVTR18DO	04697	\$20.36
PCVTR24DO	04698	\$23.96
PCVTR28DO	04699	\$25.96
PCVTR38DO	04679	\$152.52



MODULE FRAME

ITEM#	CODE	LIST PRICE
PSVTR12	04640	\$19.04
PSVTR18	04641	\$18.64
PSVTR24	04642	\$27.60
PSVTR28	04643	\$25.16
PSVTR38	04644	\$59.76

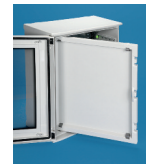

INNER DOOR

ITEM#	CODE	LIST PRICE
CP02	04631	\$40.20
CP03	04632	\$50.92
CP04	04633	\$61.60
CP05	04634	\$73.84
CP06	04635	\$93.52
CP07	04637	\$126.28

VERTICAL FRAME



ITEM#	CODE	LIST PRICE
MONT02	04651	\$12.76
MONT03	04652	\$12.76
MONT04*	04653	\$14.68
MONT06	04654	\$17.76
MONT07	04655	\$25.32

*For use with VTR04 and VTR05.

DIN RAIL ASSEMBLY

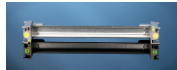

ITEM#	CODE	LIST PRICE
GUIDA12	04660	\$10.12
GUIDA18	04661	\$13.68
GUIDA24	04662	\$12.88
GUIDA28	04663	\$14.08
GUIDA38	04664	\$16.28

WALL BRACKET



ITEM#	TYPE	STANDARD CARTON QTY	LIST PRICE EACH
04688	Stainless Steel	4	\$7.86
04680	Zinc Plated	4	\$2.02

ADJUSTABLE MOUNTING PLATE BLOCK



ITEM#	CODE	STANDARD CARTON QTY	LIST PRICE EACH
SCORPF	04682	2	\$2.48

General Terms and Conditions of Sale

I. Payment Terms

Net 30 days.

II. Minimum order

\$50.00 distributor cost.

III. Freight terms

All products are F.O.B. New Jersey.

Full freight will be allowed on shipments to destinations in the continental United States for orders of: \$750 on wiring duct and accessories.

\$1,000 for wiring duct and din rail combined.

\$1,200 for din rail.

\$2000 on VTR products*

***NOTE:** VTR Freight terms and standard IBOCO terms are not to be combined in one order.

All transportation methods requested by purchaser, other than IBOCO's standard carriers, will be subject to a prepaid and add charge.

IV. Sales Tax

Prices do not include sales, excise or similar taxes.

IBOCO reserves the right to add any taxes to the sale price imposed by law on the sale of its articles.

V. Prices

IBOCO Corporation is not responsible for the accuracy of any prices, discounts or terms shown on purchaser's orders. Orders will be accepted with the understanding that the products will be billed at price in effect at time of shipment, unless otherwise specified in quotation.

VI. Ordering less than standard package quantities

Issued quotes are valid on standard carton quantity only.

10% cost premium if less than one standard carton. IBOCO does not advise shipping broken boxes due to high risk of damage. If broken box is ordered IBOCO will not be responsible for damages once order leaves our warehouse. IBOCO will not credit invoice or reship product if damage occurs.

Din rails, VTR Products, cable ties and accessories are only available in standard packaging as listed in price schedule.

VII. Cancellation

Any order may be canceled for standard products without charge prior to shipment.

Cancellations of orders already shipped, or of special products which are in the manufacturing process, will be accepted with the understanding that IBOCO Corp. will be reimbursed for costs incurred as a result of the cancellation.

VIII. Claims

Claims for shortages/or erroneous deductions for charges must be made within twenty days of invoice date or will not be permitted.

IBOCO's New **VTR Modular Fiberglass Enclosures** allow you to

THINK OUTSIDE THE BOX

WORK

Removable door pin allows for left or right hinging in the field.

Standard key, optional lock available for maximum security.

Solid or window doors. Window doors for secured inspection.

Secure and durable molded handle.

Unique "Rail Channel Guides" for adjustable depth of din rail assembly, panels and frames.

Swing out inner door for enclosure security and device protection. Allows for right or left hinging.



Threaded insert for wall bracket mounting.

Modular frames with breakout shields for device spacing.

Innovative adjustable height din rail assembly for outside the box installation and field service.

Impact and corrosion resistant fiberglass body.

Adjustable blank panel for customized installations and modifications.

THE MODULAR FIBERGLASS ENCLOSURE

NEMA4X 

An innovator in the area of wire management, IBOCO continues its rich tradition in offering the market a comprehensive range of products that provide effective, efficient installations.

The new family of modular enclosures are designed to provide the installer an "ease of use" not found with any enclosure currently in the marketplace.

The 14 sizes available (seven solid door and seven window), offer a modular adjustable frame that enables the installer to virtually adjust din rail mounting components, modular panels and inner doors to desired heights, by literally using a quick quarter turn lock-in method, plug and play.

It is also designed so you may remove the entire back plate or din rail assembly from the enclosure making installation and maintenance much easier.

The VTR series provides modular solutions to the OEM that are unparalleled in the enclosure market. The innovative rail channel guides are designed for durability, ease of installation and maintenance.



IBOCO Corporation

TEL: 732-417-0066 Email: iboco@iboco.com

Send all orders to orders@iboco.com

www.iboco.com